



Deburring

Improved design for easier and better machining

KE 6-2 – Edge deburrer for radii, drill holes, inside and outside edges

- Ideal for ensuring clean visible edges and preparing welds
- Handy and powerful device
- Setting the chamfering height without tool
- For machining building steel, aluminium and other materials
- For deburring radii and drill holes from 20 mm diameter
- With 3-fold turnover plate holder
- Manual feed
- Speed from 3,000 to 6,000 rpm continuously variable

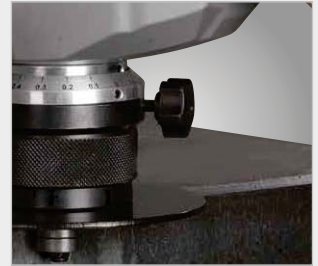

For ensuring clean visible edges e.g. with steel girders

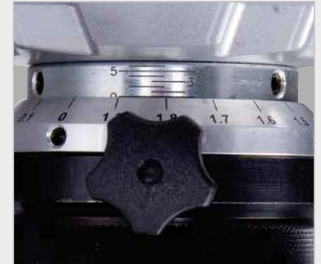

Chamfer width from 0 to 6 mm continuously variable
Convenient and exact setting of the chamfer width thanks to easy-to-read scale



With 3-fold turnover plate holder



KE 6-2 with mounted side handle

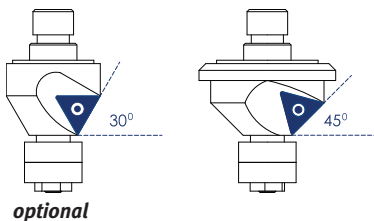

Model	KE 6-2
Art. no.	3990007
€ plus VAT	450.00
Technical specifications	
Chamfer angle	45° (optional 30°)
Chamfer width at 45°	0 - 6 mm
Electrical connections	230 V/50 Hz
Output	1,100 Watts
Speed (continuously variable)	3000 - 6000 rpm
Dimensions (L x W x H)	308 x 344 x 273 mm
Weight	4.7 kg

Scope of supply

- **Plastic case**
- 3-fold turnover plate holder 45°
- 1x Cutting plate set consisting of three 4x indexing inserts
- 1x Tool kit
- 1x Side handle

Accessories	Art. no.	€ plus VAT
① 30° tool holder	3990020	145.00
45° tool holder	3990021	145.00
Cutting plate set / VE 10	3990022	160.00
Guide roller 45°	3990023	8.90
Guide roller 30°	3990024	8.90

Improved design for easier and better machining

KE 10-2 – Edge deburrer for radii, drill holes, inside and outside edges, up to 10.6 mm chamfer width

- Ideal for ensuring clean visible edges and preparing welds
- Handy and powerful device
- Setting the chamfering height without tool
- For machining building steel, aluminium and other materials
- For deburring radii and drill holes from 30 mm diameter
- With 6-fold turnover plate holder
- Manual feed
- Speed from 2,300 to 6,500 rpm continuously variable



KE 10-2 with mounted handle

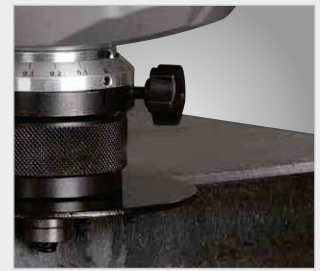
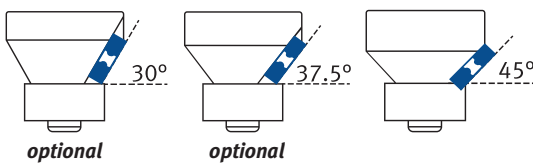

For ensuring clean visible edges e.g. with steel girders

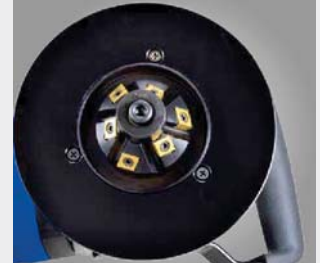

With 6-fold turnover plate holder



Chamfer width from 0 to 10.6 mm continuously variable
Convenient and exact setting of the chamfer width thanks to easy-to-read scale
3 chamfer angles 30° / 37.5° / 45°

Model	KE 10-2
Art. no.	3990012
€ plus VAT	635.00
Technical specifications	
Chamfer angle	45° (optional 30° / 37.5°)
Chamfer width at 45°	0 - 10.6 mm
Electrical connections	230 V/50 Hz
Output	1,800 Watts
Speed (continuously variable)	2300 - 6500 rpm
Dimensions (L x W x H)	485 x 192 x 150 mm
Weight	6.5 kg

- Scope of supply**
- Plastic case**
- 6-fold cutting plate holder 45°
 - 1x Cutting plate set consisting of 6 cutting plates
 - 1x Tool kit
 - 1x Front handle

Accessories	Art. no.	€ plus VAT
① Cutting plate set (6 pieces)	3991110	125.00
Milling head and guide roller 45°	3991111	210.00
Milling head and guide roller 30°	3991112	210.00
Milling head and guide roller 37.5°	3991113	210.00

New

Suction cups VS 10 - Universal device for small and medium-sized workpieces

- Easy to move to different locations in production thanks to integrated transport rollers and self-priming underside
- Height adjustable as standard
- Simultaneous processing of several small or single large workpieces
- Flexible use in production



Model	New VS 10 with vacuum pump	New VS 10 WITHOUT vacuum pump
Art. no.	5405000	5405001
€ plus VAT	1,630.00	1,360.00

Technical specifications	
Dimensions	630 x 400 x 860 – 1,100 mm
Weight incl. vacuum pump	approx. 25 kg
Extraction performance of vacuum pump	3 m ³ /h
Electrical connections	220 - 240 V, 50/60 Hz

* PTO for an explanation of the packaging surcharges; details of TVP plus VAT.

Art. no.	Option	€ plus VAT
5405005	Different suction cup sizes	without surcharge
5405006	Suction cup version continuously rotatable	100.00
5405007	Swivel operation through indexing footswitch	280.00
5405008	8 m ³ /h vacuum pump	325.00



Magnetic drilling
Deburring
Metal grinding
Cutting
Notching & punching
Bending
Presses
Circular saws
Roller conveyors
Band saws

KE 100 – Edge deburrer for exterior edges, for mobile and stationary use

- For creating clean visible edges and preparing welds
- Device for stationary or mobile use
- Easy and quick change-over from stationary to mobile use with wing nuts and removable foot
- Tool-free setting of the chamfer depth
- Standard angle settings at 15°, 30° and 45°
- Manual feed
- patented technology
- Handy and powerful device
- For machining construction steel, non-ferrous metals and plastics
- Functional arrangement of the handles allows for safe guiding of the device in mobile operation
- Guide plate equipped with adjustable ball heads for smooth running of the workpiece
- Automatic safety shutoff in case of overheating

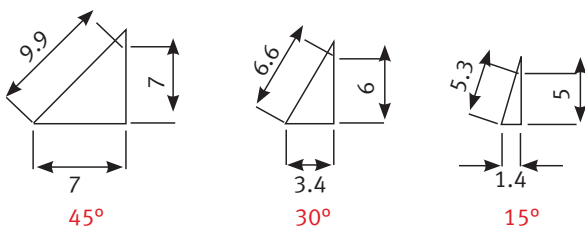

Model	KE 100
Art. no.	3992000
€ plus VAT	1,070.00

Technical specifications	
Chamfer angle	15° / 30° / 45°
Chamfer width at 15°	approx. 5 mm
Chamfer width at 30°	approx. 6 mm
Chamfer width at 45°	approx. 7 mm
Electrical connections	230 V
Output	750 W
Speed (continuously variable)	2000 - 5000 rpm
Dimensions (L x W x H max.)	360 x 230 x 280 mm
Weight	10.5 kg

Scope of supply

Edge deburring device KE 100

- Milling head with cutting plates
- 3 rubber feet
- Workpiece slide

Accessories	Art. no.	€ plus VAT
① Milling head	3992005	125.00
② Cutting plate set	3992006	40.00

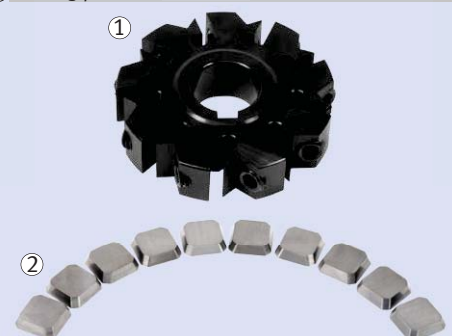

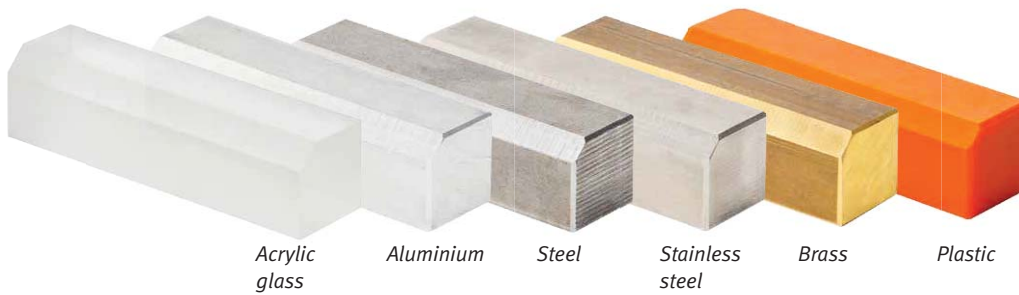
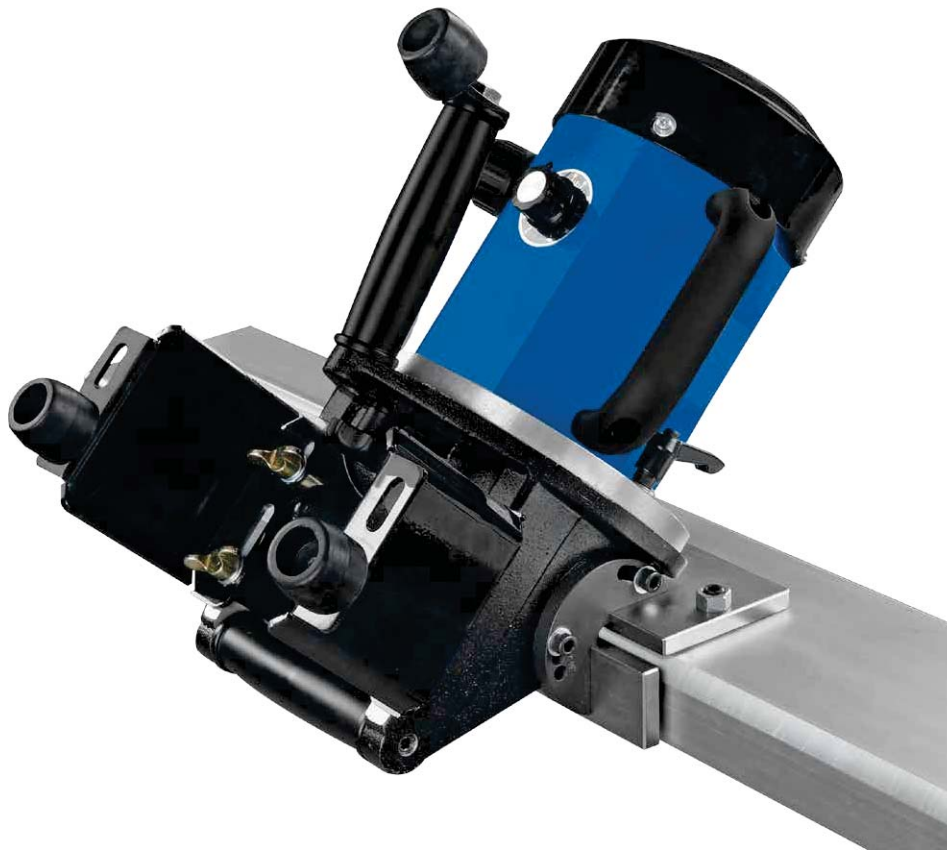

Suitable for machining metals and plastics.

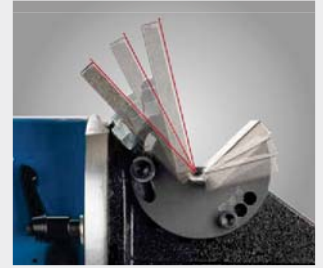

- 3 different standard angle settings 15°, 30° and 45°

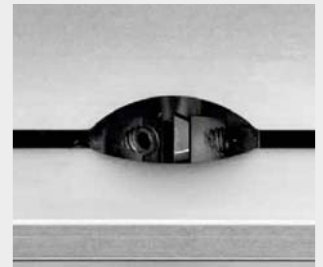

- Chamfer width between 5 and 7 mm



- Continuously adjustable speed control supports machining of various materials



- Continuously adjustable chamfer depth setting without tools supported

Typical applications



Mobile use



Stationary use

Magnetic drilling

Deburring

Metal grinding

Cutting

Notching & punching

Bending

Presses

Circular saws

Roller conveyors

Band saws

Improved design for easier and better machining

KE 16-2 – Edge deburrer for visible edges and weld seam preparation with continuous angle adjustment from 15 to 60°. Also suitable for deburring pipes thanks to adjustable guide rollers on the mounting table

- Tremendous for ensuring clean visible edges and preparing welds
- Handy and powerful device
- Setting the chamfering height without tool
- For machining building steel, aluminium and other materials
- Also suitable for deburring pipes with Ø 150-350 mm (optionally 300-600 mm) thanks to adjustable guide rollers on the mounting table
- Continuously adjustable angle adjustment from 0° - 60°
- With two 6-fold turnover plate holders
- Manual feed



KE 16-2 with mounted handle



• With two 6-fold turnover plate holders



• Continuously adjustable angle adjustment from 0°-60°
• With two rollers for easier feeding



• Deburring of pipes possible

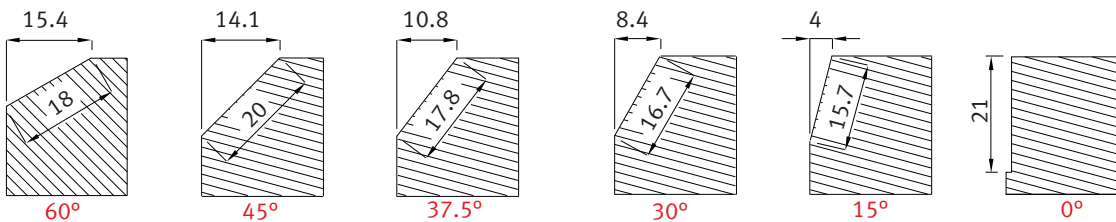

Model	KE 16-2
Art. no.	3990017
€ plus VAT	1,145.00

Technical specifications	
Chamfer angle	0 / 15 / 30 / 37.5 / 45 / 60°
Chamfer width at 0°	21 mm
Chamfer width at 15°	15.7 mm
Chamfer width at 30°	16.7 mm
Chamfer width at 37.5°	17.8 mm
Chamfer width at 45°	20 mm
Chamfer width at 60°	18 mm
Pipe diameter	150-350mm (Optionally 300-600mm)
Electrical connections	230 V/50 Hz
Output	1,100 Watts
Speed	3000 rpm
Dimensions (L x W x H)	503 x 350 x 248 mm
Weight	20.1 kg

- Scope of supply**
- Plastic case**
- 2x 6-fold cutting plate holder
 - 1x Cutting plate set consisting of 12 cutting plates
 - 1x Tool kit
 - 1x Front handle

Accessories	Art. no.	€ plus VAT
① Milling head	3991605	75.00
② Cutting plate set (12 pieces)	3991606	119.00
Support plate for pipe Ø 300–600 mm	3991607	130.00

