



Roller conveyors

Unicraft UF 230 - universal chassis for moving saws, grinding machines, drilling machines, planing machines, etc.



- load up to 230 kg
- for easy transport and relocation of your machines
- safe and stable design
- fast and easy assembly
- Wheels rotate through 360° for ease of movement
- With vibration damping feet
- With two steering rollers and clasp brake as factory standard
- grid supports various size settings, thus allowing for universal deployment

Model	UF 230
Art. no.	6190230
€ plus VAT	59.00

Technical specifications	
Minimum size square	280 x 280 mm
Maximum size square	890 x 890 mm
Minimum size rectangular	430 x 280 mm
Maximum size rectangular	1290 x 480 mm
Hole spacing	25 mm
Load-bearing capacity	230 kg



Material stand MS 3 - continuously height-adjustable, loadable up to 700 kg

- for supporting long and heavy workpieces
- universally deployable, for example, on metal-cutting circular saws, band saws, other woodworking machines, etc.
- Roller support, continuously adjustable and clampable
- safe workpiece support due to solid steel rollers with high load-bearing capacity
- heavy three-leg cast iron version for highest loads

Model	MS 3	MS 3 V
Art. no.	3660700	3660705
€ plus VAT	79.00	79.00

Technical specifications		
Load-bearing capacity	700 kg	700 kg
Roller width	400 mm	2 x 130 mm
Min./max. height	580 / 970 mm	580 / 970 mm
Type	Steel rollers	Steel rollers
Roller diameter	52 mm	52 mm



Material stand MS 4 - continuously adjustable

- different roller types available
- Roller support, continuously adjustable
- extra wide support
- Universally deployable



MS 4 R

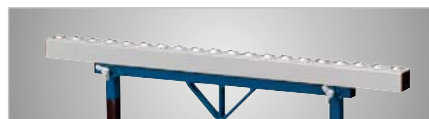

MS 4 K

Model	MS 4	MS 4 R	MS 4 K
Art. no.	3660110	3660111	3660112
€ plus VAT	735.00	855.00	879.00

Technical specifications			
Load-bearing capacity	500 kg	500 kg	500 kg
Length	700 mm	980 mm	1000 mm
Min./max. height	760 / 1030 mm	700 / 960 mm	700 / 960 mm
Type	Plastic roller	Multi-directional roller track	Ball transfer track
Roller diameter	90 mm	-	-



MRB LC - the roller and measuring track system with a lightweight design and a load-bearing capacity of 100 kg pro metre of roller conveyor

- Roller and measuring track system for precise sawing, drilling or milling of lighter wood metal and plastic sections
- Sub-structure made of solid 3 mm steel sections, painted and with adjustable feet
- Idler rollers made of galvanised steel (optionally also available with plastic idler rollers)

Especially for MRB LC-B and MRB LC-E
The stop carriage is 4x roller borne, and thus easy to move manually

- Stop arm is adjustable and can be tilted to the rear
- The maximum measuring length is the track length minus the stop length
- MRB LC-B: 250 mm
- MRB LC-E: 250 mm



Quality Made in Germany



MRB LC-B: supplied with magnifying glass as standard for easier reading off of the millimetre scale

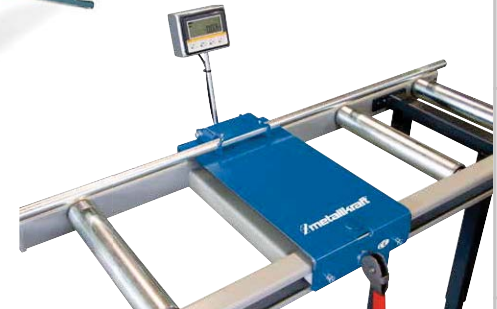

MRB LC-E
 with magnetic strip, length measuring unit with digital display and 4x roller borne stop carriage

Technical data MRB LC series	
Roller diameter	50 mm
Shaft diameter	8 mm
usable roller width	300 mm
load-bearing capacity per metre	100 kg/m
Working height	770 - 1,070 mm

Optional

Additional supporting leg for MRB LC-C, LC-B and LC-E Art. no. 3663000; € 89.00 plus VAT.

Plastic rollers (surcharge per metre)	Art. no.	€ plus VAT
for LC roller conveyors	3669990	15.00

MRB LC-C

Feed roller conveyor without cross-cut fence and without measuring system

Length	Roller conveyor feet	Art. no.	€ plus VAT
2 m	2	3662320	395.00*
3 m	3	3662330	565.00*
4 m	3	3662340	715.00*
5 m	4	3662350	885.00**
6 m	5	3662360	1,050.00**

MRB LC-B

Stop track with cross-cut fence, manual measuring system with mm scale and magnifying glass for reading off, stop adjustable and can be tilted to the rear

Length	Roller conveyor feet	Art. no.	€ plus VAT
2 m	2	3662220	659.00*
3 m	3	3662230	865.00*
4 m	3	3662240	1,079.00*
5 m	4	3662250	1,285.00**
6 m	5	3662260	1,505.00**

MRB LC-E

Roller conveyor with cross-cut fence, magnetic tape measuring system with digital display, otherwise as per MRB LC-B

Length	Roller conveyor feet	Art. no.	€ plus VAT
2 m	2	3662420	1,175.00*
3 m	3	3662430	1,539.00*
4 m	3	3662440	1,885.00*
5 m	4	3662450	2,249.00**
6 m	5	3662460	2,615.00**

* Transport/insurance packaging TVP 3 = 59.00 € plus VAT per roller conveyor is required for roller conveyors with a length of 2 – 4 m
 ** Transport/insurance packaging TVP 4 = 79.00 € plus VAT per roller conveyor is required for roller conveyors with a length of 5 – 8 m

Assembly adapter



for stable fastening of MRB LC series roller conveyors to Metalkraft metal-cutting circular saws The adapters are specially designed for installation on the right or left of the saws

Assembly adapter

Saw type	Assembly position	Art. no.	€ plus VAT
MKS 250 N	right	3672201	115.00
MKS 250 N	left	3672101	115.00
MKS 315 N	right	3672202	115.00
MKS 315 N	left	3672102	115.00
MKS315V	right	3672204	90.00
MKS315V	left	3672104	90.00

Saw type	Assembly position	Art. no.	€ plus VAT
MKS350 V	right	3672205	115.00
MKS350 V	left	3672105	90.00
LMS400	right	3672203	115.00
LMS400	left	3672103	90.00
LMS 400 PRO	right	3672206	108.00
LMS 400 PRO	left	3672106	108.00

MRB standard - the roller and measuring track system with a robust design and a load-bearing capacity of 300 kg pro metre of roller conveyor

- sturdy U-shaped, closed design made from 3 mm sheet metal sections.
- Idler rollers made of galvanised steel
- all roller conveyors in the MRB Standard series are also available with plastic idler rollers (see plastic rollers at the bottom of the next page)
- Ball-bearing borne idler rollers

- The maximum measuring length is the track length minus the stop length

MRB Standard A: 450 mm
MRB Standard BKF: 400 mm
MRB Standard B, EP: 260 mm

Technical specifications	
Roller diameter	60 mm
Shaft diameter	15 mm
Usable roller width	250 / 350 mm
load-bearing capacity per metre	300 kg/m
Height-adjustable feet	+/- 60 mm
Working height	880 mm

MRB Standard C

- Feed/discharge roller conveyors
- Roller conveyors without a scale and stop with lateral guides



MRB Standard C

MRB Standard B

- With with length measuring unit
- Roller and measuring track with mm scale, manual measuring system with C guide profile and adjustable folding stop



MRB Standard B

MRB Standard BKF

- Precision flat steel guide attached to rear of roller conveyor
- sturdy, 6x ball bearing borne material stop carriage, easy action, manually adjustable and clampable
- Stop carriage with magnifying glass facilitates reading off the mm scale
- robust stop arm mounted on stop carriage; adjustable up to tool (0 point)

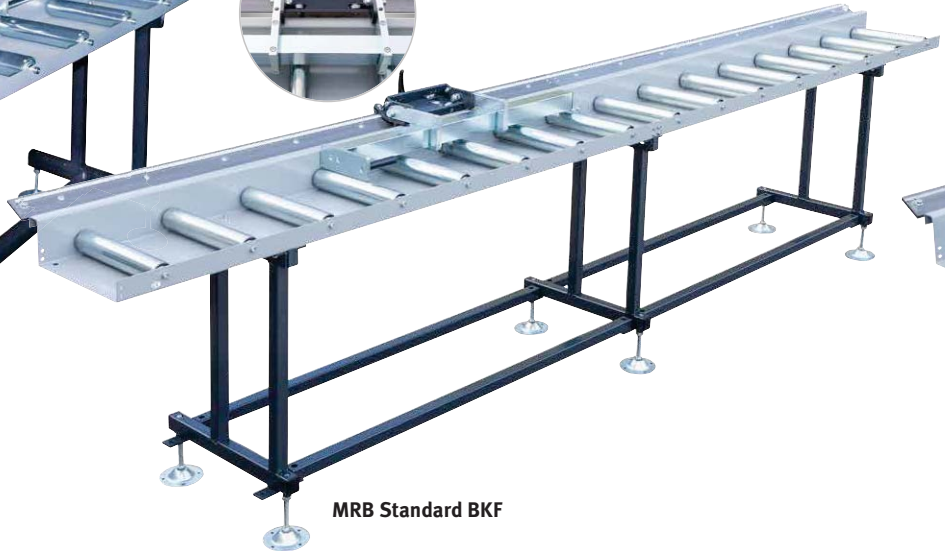
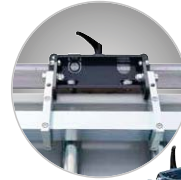

MRB Standard BKF

MRB Standard C

MRB Standard C - track width 300 mm (usable roller width 250 mm)

Length	Roller track feet	Art. no.	€ plus VAT
1 m	2	3661311	389.00*
2 m	2	3661312	665.00*
3 m	3	3661313	845.00*
4 m	3	3661314	1,055.00*
5 m	4	3661315	1,329.00**
6 m	5	3661316	1,599.00**
7 m	5	3661317	1,819.00**
8 m	6	3661318	2,099.00**

MRB Standard B - track width 300 mm (usable roller width 250 mm)

Length	Roller track feet	Art. no.	€ plus VAT
1 m	2	3661211	615.00*
2 m	2	3661212	935.00*
3 m	3	3661213	1,225.00*
4 m	3	3661214	1,489.00*
5 m	4	3661215	1,829.00**
6 m	5	3661216	2,165.00**
7 m	5	3661217	2,479.00**
8 m	6	3661218	2,805.00**

MRB Standard BKF - track width 300 mm (usable roller width 250 mm)

Length	Roller track feet	Art. no.	€ plus VAT
1 m	2	3661231	1,210.00*
2 m	2	3661232	1,589.00*
3 m	3	3661233	1,985.00*
4 m	3	3661234	2,395.00*
5 m	4	3661235	2,785.00**
6 m	5	3661236	3,179.00**
7 m	5	3661237	3,589.00**
8 m	6	3661238	3,985.00**

MRB Standard C - track width 400 mm (usable roller width 350 mm)

Length	Roller track feet	Art. no.	€ plus VAT
1 m	2	3661321	425.00*
2 m	2	3661322	735.00*
3 m	3	3661323	1,009.00*
4 m	3	3661324	1,199.00*
5 m	4	3661325	1,515.00**
6 m	5	3661326	1,839.00**
7 m	5	3661327	2,089.00**
8 m	6	3661328	2,415.00**

MRB Standard B - track width 400 mm (usable roller width 350 mm)

Length	Roller track feet	Art. no.	€ plus VAT
1 m	2	3661221	635.00*
2 m	2	3661222	1,025.00*
3 m	3	3661223	1,335.00*
4 m	3	3661224	1,579.00*
5 m	4	3661225	1,985.00**
6 m	5	3661226	2,389.00**
7 m	5	3661227	2,695.00**
8 m	6	3661228	3,089.00**

MRB Standard BKF - track width 400 mm (usable roller width 350 mm)

Length	Roller track feet	Art. no.	€ plus VAT
1 m	2	3661241	1,235.00*
2 m	2	3661242	1,625.00*
3 m	3	3661243	2,065.00*
4 m	3	3661244	2,469.00*
5 m	4	3661245	2,909.00**
6 m	5	3661246	3,349.00**
7 m	5	3661247	3,755.00**
8 m	6	3661248	4,195.00**

* Transport/insurance packaging TVP 4 = 79.00 € plus VAT per roller conveyor is required for roller conveyors with a length of 2 – 4 m

** Transport/insurance packaging TVP 5 = 100.00 € plus VAT per roller conveyor is required for roller conveyors with a length of 5 – 8 m

Assembly adapters on Metalkraft metal-cutting circular saws

The adapters are specially designed for installation on the right or left of the saws for the MRB Standard series on Metalkraft metal-cutting circular saws **Please state your sawing machine type with your order.**

For assembly of the MRB Standard models (300 mm):

Saw type	Assembly pos.	Art. no.	€ plus VAT
MKS250N	right	3671211	115.00
MKS250N	left	3671111	115.00
MKS 315 N	right	3671212	115.00
MKS 315 N	left	3671112	115.00
MKS315V	right	3671214	115.00
MKS315V	left	3671114	115.00
MKS350 V	right	3671215	115.00
MKS350 V	left	3671115	115.00
LMS400	right	3671213	115.00
LMS400	left	3671113	90.00

For assembly of the MRB Standard models (400 mm):

Saw type	Assembly pos.	Art. no.	€ plus VAT
MKS 250 N	right	3671221	115.00
MKS 250 N	left	3671121	115.00
MKS315N	right	3671222	115.00
MKS315N	left	3671122	115.00
MKS315V	right	3671224	115.00
MKS315V	left	3671124	115.00
MKS350 V	right	3671225	115.00
MKS350 V	left	3671125	115.00
LMS400	right	3671223	115.00
LMS400	left	3671123	90.00

Please state installation side and height with order!
Working height up to 1020 mm possible with optional foot plate.

On request:
Working height as of 1020 mm extensible as factory option
· also with 500 mm track width

MRB Standard EKF

- As per MRB Standard BKF
- With length measuring unit and digital dimension display system
- Roller and measuring track with battery operated LCD display and magnetic strip measuring system

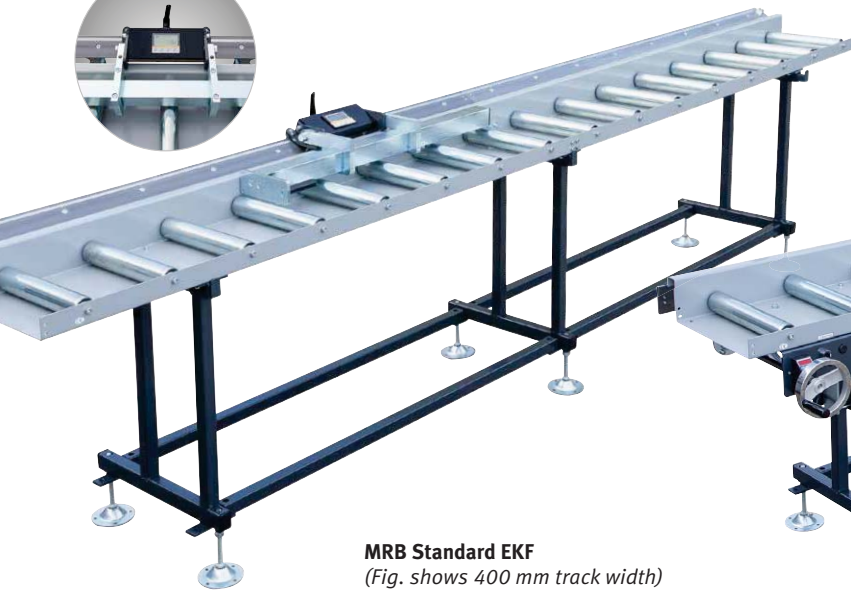
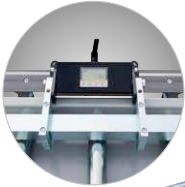

MRB Standard EKF
(Fig. shows 400 mm track width)

MRB Standard A

- Length measuring unit with handwheel adjustment
- Roller and measuring track with LED dimension display (mm), incl. mains adapter 230 V
- Measuring stop adjustable via handwheel from workplace, with pneumatic brake for dimensional fixing
- robust material stop carriage, 12x ball-bearing borne, movable on generously dimensioned guide profile; the stop arm is adjustable and can be folded back
- a cable drag chain is required for roller conveyors with a length of more than 5 m
- Installation side right or left, in line with customer's needs

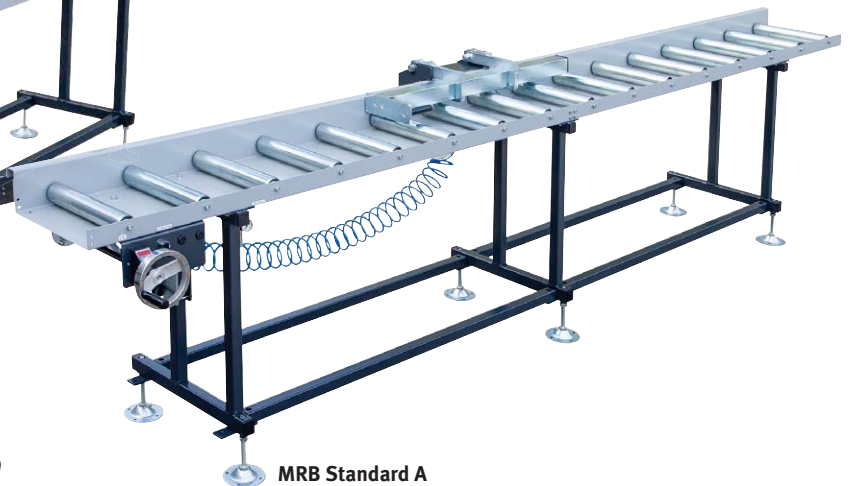

MRB Standard A

MRB Standard EKF - track width 300 mm (usable roller width 250 mm)

Length	Roller track feet	Art. no.	€ plus VAT
1 m	2	3661711	1,555.00*
2 m	2	3661712	2,020.00*
3 m	3	3661713	2,500.00*
4 m	3	3661714	3,000.00*
5 m	4	3661715	3,485.00**
6 m	5	3661716	3,965.00**
7 m	5	3661717	4,465.00**
8 m	6	3661718	4,950.00**

MRB Standard EKF - track width 400 mm (usable roller width 350 mm)

Length	Roller track feet	Art. no.	€ plus VAT
1 m	2	3661721	1,575.00*
2 m	2	3661722	2,055.00*
3 m	3	3661723	2,585.00*
4 m	3	3661724	3,080.00*
5 m	4	3661725	3,600.00**
6 m	5	3661726	4,140.00**
7 m	5	3661727	4,635.00**
8 m	6	3661728	5,160.00**

MRB Standard A - track width 300 mm (usable roller width 250 mm)

Length	Roller track feet	Art. no.	€ plus VAT
2 m	2	3661112	2,359.00*
3 m	3	3661113	2,705.00*
4 m	3	3661114	3,169.00*
5 m	4	3661115	3,609.00**
6 m	5	3661116	4,295.00**
7 m	5	3661117	4,795.00**
8 m	6	3661118	5,275.00**

MRB Standard A - track width 400 mm (usable roller width 350 mm)

Length	Roller track feet	Art. no.	€ plus VAT
2 m	2	3661122	2,435.00*
3 m	3	3661123	2,789.00*
4 m	3	3661124	3,245.00*
5 m	4	3661125	3,745.00**
6 m	5	3661126	4,469.00**
7 m	5	3661127	4,959.00**
8 m	6	3661128	5,489.00**

- 5-digit LED dimension display for continuous checking of the current stop carriage state with millimetre accuracy
- Position display with hollow shaft rotary encoder mounted directly on the drive shaft
- Measuring precision: 2/10 mm
- 900 mm stop arm length
- Guide plate adjustable to zero point; can be folded to the rear manually
- Multiply ball bearing-borne and thus free from play

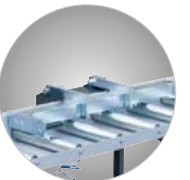

Option foot plate with spindle M 16 x 250 mm
For height adjustment up to 1020 mm
● Art. no. 3679000, € 24.00 € plus VAT per foot

Plastic rollers (surcharge per metre)	Art. no.	€ plus VAT
for MR Standard roller conveyors with a track width of 300 mm	3669991	15.00
for MR Standard roller conveyors with a track width of 400 mm	3669992	26.00

* Transport/insurance packaging TVP 4 = 79.00 € plus VAT per roller conveyor is required for roller conveyors with a length of 2 – 4 m
** Transport/insurance packaging TVP 5 = 100.00 € plus VAT per roller conveyor is required for roller conveyors with a length of 5 – 8 m

Optional accessories - extension of the roller and measuring track MRB Standard for more effective and time-saving work

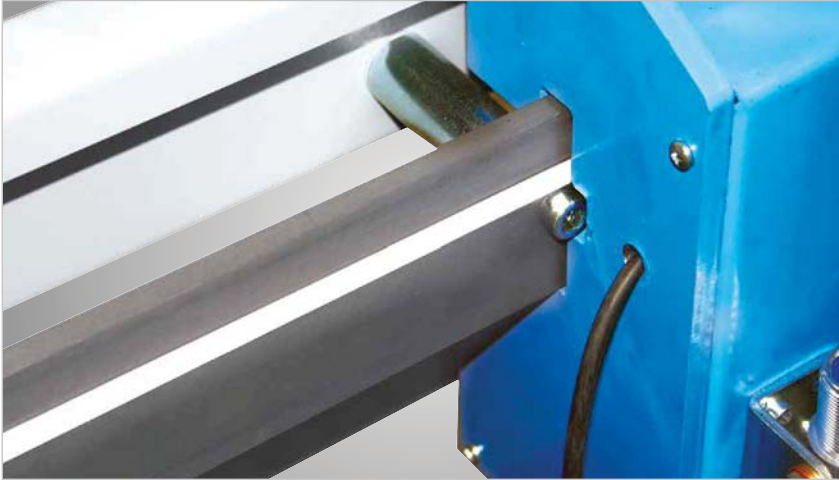

- Direct magnetic belt measuring system
- Delivery of direct magnetic belt measuring system including display unit Z58
- Independent stop carriage and length measuring drives
- Dimension is displayed via display unit Z58
- Sensor head mounted directly on the stop carriage
- Dimensional and repetition accuracy ± 0.1 mm per metre
- Cable and air ducting via energy drag chain

Length	Art. no.	€ plus VAT
2 m	3672232	950.00
3 m	3672233	1,053.00
4 m	3672234	1,229.00
5 m	3672235	1,333.00
6 m	3672236	1,490.00
7 m	3672237	1,613.00
8 m	3672238	1,770.00



Display unit Z58

- for convenient reading off of the set values thanks to 1/10 mm LED display
- receives the input signals via magnetised pole ring and a sensor head attached directly to the drive shaft
- Measuring accuracy of ± 0.2 mm per metre
- easy to read off
- Art. no. 3672220; € 626.00 plus VAT

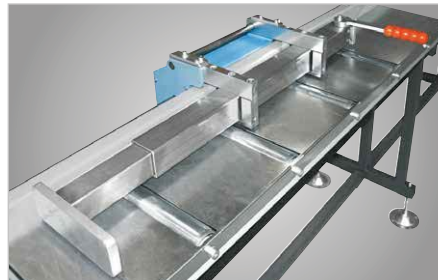

Spring-loaded stop arm SZ 05

- with spring-loaded material stop arm
- adjustable to the 0 point
- swivels to the rear manually
- equipped with an eccentric lever for adjusting the release action
- Art. no. 3672221; € 388.00 plus VAT



Pneumatic arm retractor

- **only available in combination with spring loaded stop arm SZ 05**
- ideal for mitre cuts
- avoids the workpiece skewing
- pneumatic arm retraction (release) from the material stop
- Release stroke 10 mm
- Art. no. 3672222; € 316.00 plus VAT



Material arm pneumatically swivelling

- Device for pneumatically swivelling the material arm to the rear
- a pneumatic cylinder handles this task; easy and convenient operation from the central control panel
- Art. no. 3672223; € 369.00 plus VAT



Cover sheet galvanised zinc coated

- Cover plate for assembly between the idler rollers
- galvanised zinc coated
- removable
- Price per metre of sheet metal
- Art. no. 3672224; € 89.00 plus VAT



Optional roller conveyor feet for table heights up to 1020 mm

- Option foot plate with spindle M 16 x 250 mm
- Raises the working height up to 1020 mm
- Art. no. 3679000; € 24.00/pc. plus VAT